

**BenQ**

G2420HDB

24" Wide-Screen LCD Monitor

User Manual

**Welcome**

## Copyright

Copyright © 2009 by BenQ Corporation. All rights reserved. No part of this publication may be reproduced, transmitted, transcribed, stored in a retrieval system or translated into any language or computer language, in any form or by any means, electronic, mechanical, magnetic, optical, chemical, manual or otherwise, without the prior written permission of BenQ Corporation.

## Disclaimer

BenQ Corporation makes no representations or warranties, either expressed or implied, with respect to the contents hereof and specifically disclaims any warranties, merchantability or fitness for any particular purpose. Further, BenQ Corporation reserves the right to revise this publication and to make changes from time to time in the contents hereof without obligation of BenQ Corporation to notify any person of such revision or changes.

## Please follow these safety instructions for best performance, and long life for your monitor

### Power Safety

- The AC plug isolates this equipment from the AC supply.
- The power supply cord serves as a power disconnect device for pluggable equipment. The socket outlet should be installed near the equipment and be easily accessible.
- This product should be operated from the type of power indicated on the marked label. If you are not sure of the type of power available, consult your dealer or local power company.

### Care And Cleaning

- **Cleaning.** Always unplug your monitor from the wall outlet before cleaning. Clean the LCD monitor surface with a lint-free, non-abrasive cloth. Avoid using any liquid, aerosol or glass cleaners.
- Slots and openings on the back or top of the cabinet are for ventilation. They must not be blocked or covered. Your monitor should never be placed near or over a radiator or heat source, or in a built-in installation unless proper ventilation is provided.
- Never push objects or spill liquid of any kind into this product.

### Servicing



- Do not attempt to service this product yourself, as opening or removing covers may expose you to dangerous voltages or other risks. If any of the above mentioned misuse or other accident such as dropping or mishandling occurs, contact qualified service personnel for servicing.

# Table of Contents

<b>Getting started</b> .....	<b>4</b>
<b>Getting to know your monitor</b> .....	<b>6</b>
Front view .....	6
Back view .....	6
<b>How to assemble your monitor hardware</b> .....	<b>7</b>
How to detach the stand base .....	10
<b>Getting the most from your BenQ monitor</b> .....	<b>11</b>
How to install the monitor on a new computer .....	12
How to upgrade the monitor on an existing computer .....	13
How to install on Windows Vista systems .....	14
How to install on Windows XP system .....	15
<b>Picture optimization</b> .....	<b>16</b>
<b>How to adjust your monitor</b> .....	<b>17</b>
The control panel .....	17
Hot key mode .....	18
Main menu mode .....	19
<b>Troubleshooting</b> .....	<b>28</b>
Frequently asked questions (FAQ) .....	28
Need more help? .....	29

# 1. Getting started

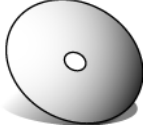
When unpacking please check you have the following items. If any are missing or damaged, please contact the place of purchase for a replacement.

BenQ LCD Monitor	
Monitor Base	
Quick Start Guide	
CD-ROM	
Power Cord (Picture may differ from product supplied for your region)	
Signal Cable: D-Sub	

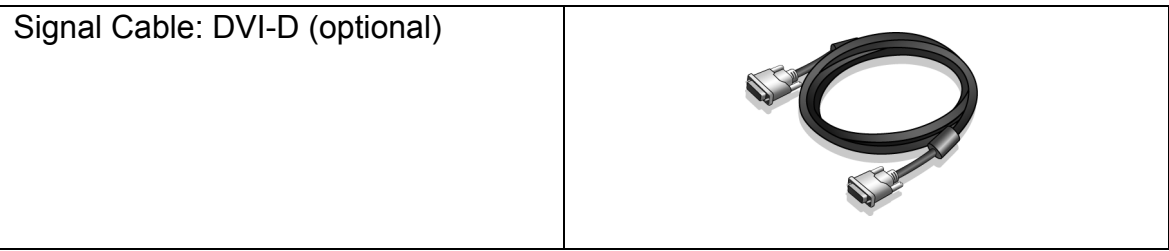

💡 Consider keeping the box and packaging in storage for use in the future when you may need to transport the monitor. The fitted foam packing is ideal for protecting the monitor during transport.

## 2. Getting to know your monitor

Front view



Back view

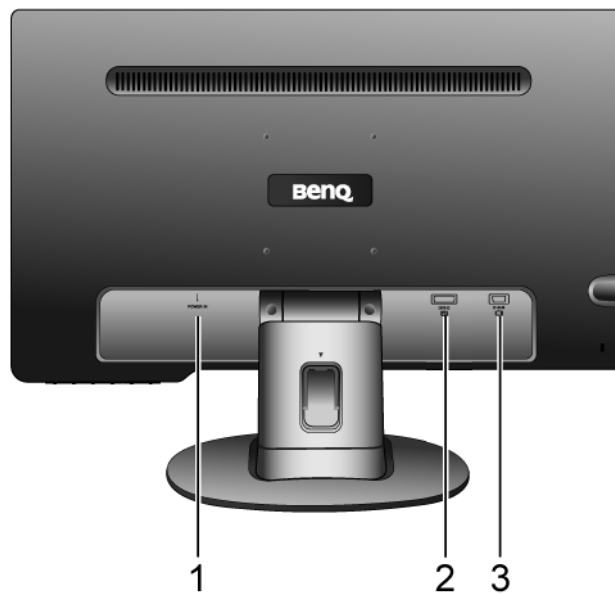

1. AC power input jack
2. DVI-D input jack
3. D-Sub input jack

### 3. How to assemble your monitor hardware

☞ If the computer is turned on you must turn it off before continuing.  
Do not plug-in or turn-on the power to the monitor until instructed to do so.

1. Attach the monitor base.

☞ Please be careful to prevent damage to the monitor. Placing the screen surface on an object like a stapler or a mouse will crack the glass or damage the LCD substrate voiding your warranty. Sliding or scraping the monitor around on your desk will scratch or damage the monitor surround and controls.

Protect the monitor and screen by clearing a flat open area on your desk and placing a soft item like the monitor packaging bag on the desk for padding.

Gently lay the screen face down on a flat clean padded surface.

While holding the monitor firmly against the desk, pull the monitor stand arm upwards clear of the monitor.

Orient and align the stand base socket with the end of the stand arm, then push them together until they click and lock into place.

Gently attempt to pull them back apart to check that they have properly engaged.

Carefully lift the monitor, turn it over and place it upright on its stand on a flat even surface.

💡 You should position the monitor and angle the screen to minimize unwanted reflections from other light sources.

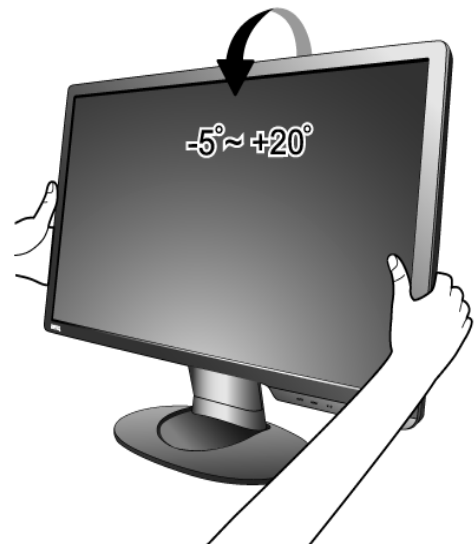

2. Connect the PC video cable.

Do not use both DVI-D cable and D-Sub cable on the same PC. The only case in which both cables can be used is if they are connected to two different PCs with appropriate video systems.

Connect one end of the DVI-D cable to the monitor DVI-D jack and the other end to the DVI-D port on your computer. (optional)

The DVI-D format is used for direct digital connection between source video and digital LCD monitors or projectors. The digital video signals produce a superior quality picture than analog video signals.

Connect the plug of the D-Sub cable (at the end without the ferrite filter) to the monitor D-Sub jack. Connect the other plug of the D-Sub cable (at the end with the ferrite filter) to the computer video D-Sub jack.

Tighten all finger screws to prevent the plugs from accidentally falling out during use.

3. Connect the power cable to the monitor.

Plug one end of the power cord into the jack labelled 'POWER IN' on the rear of the monitor. Do not connect the other end to a power outlet just yet.

**Either**

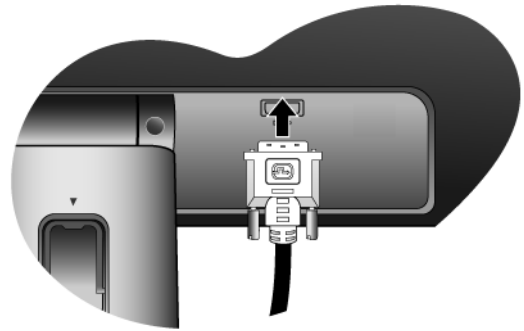

**Or**

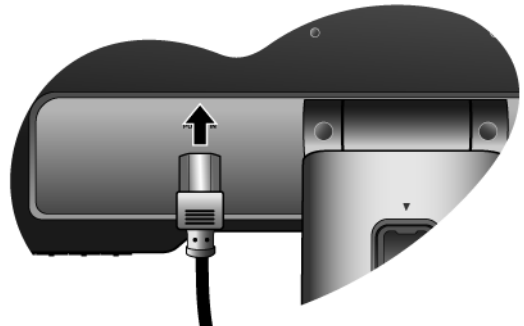
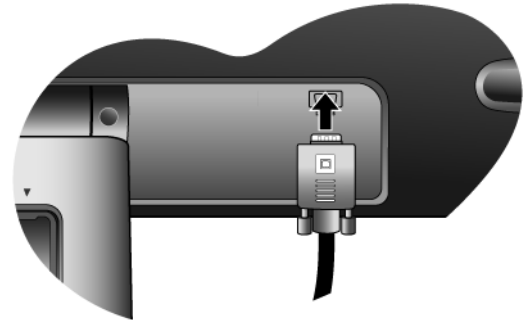



4. Route the cables via the cable clip.

Release the cable retaining clip by squeezing the clip inwards as illustrated. Position the cables together and reinsert the clip over them to retain the cables neatly in place behind the monitor stand.

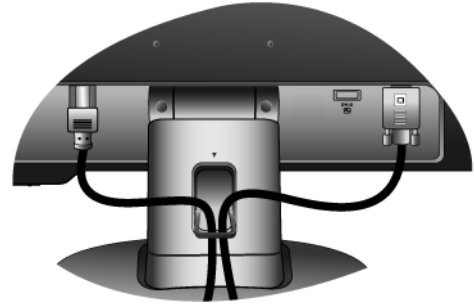
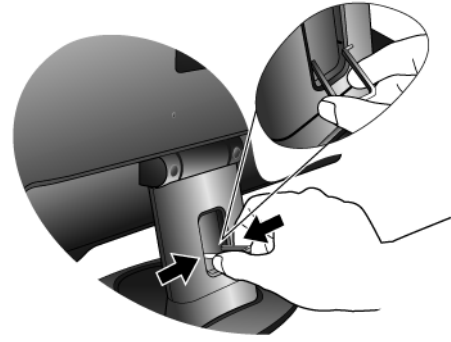

5. Connect-to and turn-on the power.

Plug the other end of the power cord into a power outlet and turn it on.

 Picture may differ from product supplied for your region.

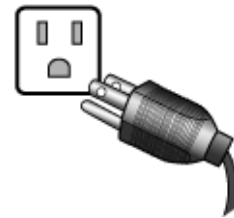

Turn on the monitor by pressing the power key.

Turn on the computer too, and follow the instructions in Section 4: [Getting the most from your BenQ monitor on page 11](#) to install the monitor software.

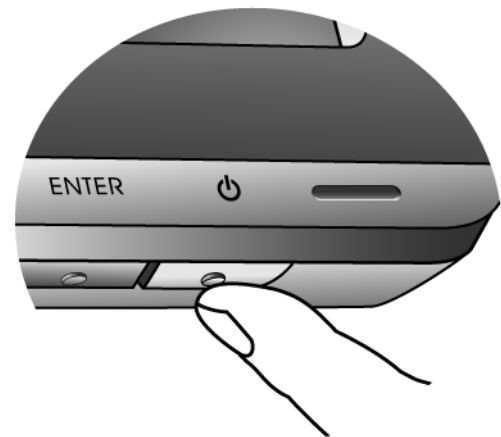

## How to detach the stand base

### 1. Prepare the monitor and area.

Turn off the monitor and the power before unplugging the power cable. Turn off the computer before unplugging the monitor signal cable.

☞ Please be careful to prevent damage to the monitor. Placing the screen surface on an object like a stapler or a mouse will crack the glass or damage the LCD substrate voiding your warranty. Sliding or scraping the monitor around on your desk will scratch or damage the monitor surround and controls.

Protect the monitor and screen by clearing a flat open area on your desk and placing a soft item like a towel on the desk for padding, before laying the screen face down on a flat clean padded surface.

### 2. Press the locking clips to detach the monitor base from the monitor stand arm.

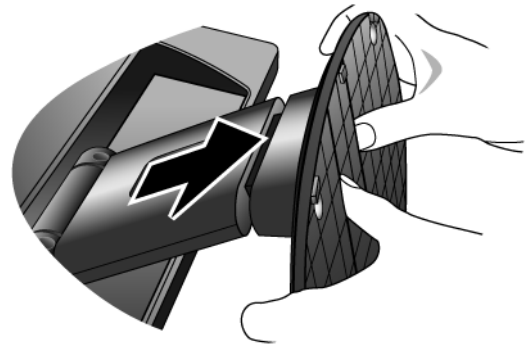
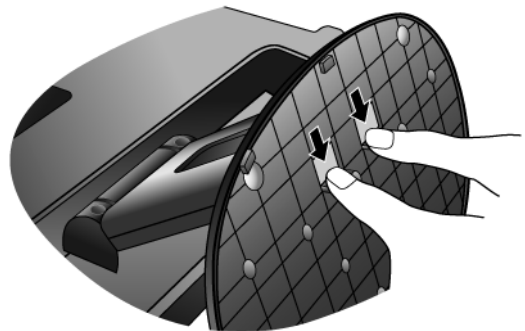

## 4. Getting the most from your BenQ monitor

To gain the most benefit from your new BenQ color LCD flat screen monitor, you should install the custom BenQ LCD Monitor driver software as provided on the BenQ LCD Monitor CD-ROM.

The circumstances under which you connect and install your BenQ LCD Monitor will determine which process you need to follow to successfully install the BenQ LCD Monitor driver software. These circumstances relate to which version of Microsoft Windows you are using, and whether you are connecting the monitor and installing the software onto a new computer (without existing monitor driver software), or whether you are upgrading an existing installation (which already has existing monitor driver software) with a newer monitor.

In either case however, the very next time you turn on your computer (after connecting the monitor to your computer), Windows will automatically recognise the new (or different) hardware, and will launch its **Found New Hardware** wizard.

Follow the wizard instructions until it asks you to select a monitor model. At that point, click the **Have Disk** button, insert the BenQ LCD Monitor CD-ROM and select the appropriate monitor model. Further details and step-by-step instructions for both an automatic (new) or upgrade (existing) installation follow. See:

- [How to install the monitor on a new computer on page 12.](#)
- [How to upgrade the monitor on an existing computer on page 13](#)

 If you require a User Name and Password to login to your Windows computer, you must be logged on as an Administrator or as a member of the Administrators group in order to install the monitor driver software. Furthermore, if your computer is connected to a network which has security access requirements, network policy settings may prevent you from installing software on your computer.

## How to install the monitor on a new computer

This instruction details the procedure for selecting and installing the BenQ LCD Monitor driver software on a new computer which has never had a monitor driver installed before. This instruction is only suitable for a computer which has never been used before, and for which the BenQ LCD Monitor is the first ever monitor to be connected to it.

 If you are adding the BenQ LCD Monitor to an existing computer that has already had another monitor connected to it (and has monitor driver software installed), you should not be following these instructions. You should instead be following the instructions for How to upgrade the monitor on an existing computer.

1. Follow the instructions in [How to assemble your monitor hardware on page 7](#).  
When Windows starts, it will automatically detect the new monitor and launch the **Found New Hardware Wizard**. Follow the prompts until it displays the option to **Install Hardware Device drivers**.
2. Insert the BenQ LCD Monitor CD-ROM into a CD drive on the computer.
3. Check **Search for a suitable driver for my device** option, and click **Next**.
4. Check the option for **CD-ROM drives** (uncheck all others) and click **Next**.
5. Look to confirm that the wizard has selected the correct name of your monitor and click **Next**.
6. Click **Finish**.
7. Restart the computer.

## How to upgrade the monitor on an existing computer

This instruction details the procedure for manually updating the existing monitor driver software on your Microsoft Windows computer. It is currently tested as compatible for Windows XP and Windows Vista Operating System (OS).

 The BenQ LCD Monitor driver for your model may well function perfectly with other versions of Windows, however, as at the time of writing, BenQ has done no testing of this driver on other versions of Windows and cannot guarantee its operation on those systems.

Installing monitor driver software involves selecting an appropriate information file (.inf) on the BenQ LCD Monitor CD-ROM for the particular model monitor you have connected, and letting Windows install the corresponding driver files from the CD. You need only steer it in the right direction. Windows has an Upgrade Device Driver Wizard to automate the task and guide you through the file selection and installation process.

See:

- [How to install on Windows Vista systems on page 14.](#)
- [How to install on Windows XP system on page 15.](#)

## How to install on Windows Vista systems

1. Open **Display Settings**.

Right-click the desktop and select **Personalize** from the popup menu.

Select **Display Settings** from the **Personalize appearance and sounds** window.

The **Display Settings** window will display.

2. Click the **Advanced Settings** button.

The **Generic PnP Monitor Properties** window will display.

3. Click the **Monitor** tab and the **Properties** button.

4. Click **Continue** in the prompted **User Account Control** window.

5. Click the **Driver** tab and the **Update Driver** button.

6. Insert the BenQ LCD Monitor CD-ROM into a CD drive on the computer.

7. In the **Update Driver Software** window, select the option '**Browse my computer for driver software**'.

8. Click '**Browse**' and navigate to the following directory: d:\BenQ\_LCD\Driver\ (where d is the drive letter designator for the CD-ROM drive).

 The drive letter for your CD drive may differ from the example above depending upon your system – it may be 'D:' or 'E:' or 'F:' etc.

9. Select the correct folder name of your monitor from provided driver list, and click **Next**.

This will copy and install the appropriate monitor driver files to your computer.

10. Click **Close**.

You do not need to restart Windows Vista, as the BenQ LCD monitor drivers will operate immediately with no further action required by you.

## How to install on Windows XP system

### 1. Open **Display Properties**.

The quickest shortcut to **Display Properties** is through the Windows desktop. Right-click the desktop and select **Properties** from the popup menu.

Alternatively, the Windows menu to **Display Properties** is located in **Control Panel**.

In Windows XP version, **Control Panel** is located directly under the main **Start** menu item.

The menu options displayed will depend upon which type of view is selected for your system.

- Under the Classic view, click **Start | Control Panel | Display**.
- Under the Category view, click **Start | Control Panel | Appearance and Themes | Change the screen resolution**.

The **Display Properties** window will display.

### 2. Click the **Settings** tab and the **Advanced** button.

The **Advanced Display Properties** window will display.

### 3. Click the **Monitor** tab and select the 'Plug and Play Monitor' from the list.

If there is only one monitor in the list, it will already be selected for you.

### 4. Click the **Properties** button.

The **Monitor Properties** window will display.

If the driver provider is listed as BenQ, and the model matches that of your new monitor, the proper drivers are already installed, and you need do nothing further. Cancel out of these property windows. However, if BenQ is not listed as the manufacturer, or the correct model is not currently shown, you will need to continue with these instructions.

### 5. Click the **Driver** tab and the **Update Driver** button.

The **Hardware Update Wizard** will display. Follow the wizard instructions noting the steps below:

### 6. Insert the BenQ LCD Monitor CD-ROM into a CD drive on the computer you attached the monitor to.

### 7. Check the option '**Install from a list or specific location**' and click **Next**.

### 8. Check the option '**Search for the best driver in these locations**' and also check '**Search removable media**', then click **Next**.

Please wait while the wizard searches for drives and the BenQ LCD Monitor CD inserted in step 6. When completes, the wizard should have found and selected the BenQ driver on the CD appropriate to your monitor model.

### 9. Select (single-click) the correct name of your monitor from provided driver list on the CD, and click the **Next** button.

This will copy and install the appropriate monitor driver files to your computer.

### 10. Click **Finish**.

This will close the wizard and return you to the **Monitor Properties** window.

### 11. Click **Close**, **OK**, and **OK**.

This will close the **Display Properties** windows. You do not need to restart Windows XP, as the BenQ LCD monitor drivers will operate immediately with no further action required by you.

## 5. Picture optimization

The easiest way to obtain an optimal display from an analog (D-Sub) input is to use the **AUTO** key function. Press the **AUTO** key to optimize the currently displayed image to the screen.

 When you connect a digital video output using a digital (DVI) cable to your monitor, the **AUTO** key and the **Auto Adjustment** function will be disabled, because the monitor will automatically display the best image.

 Please ensure that the connected graphic card on your computer is set to the native resolution of the monitor when you use the **AUTO** key function.

If you wish, you can always adjust the screen geometric settings manually using geometry menu items. To assist you in this endeavour, BenQ has provided a screen test image utility which you can use to check for screen color, grayscale and line gradient display.

1. Run the test program auto.exe from CD-ROM. You could also use any other image, such as the desktop of your operating system. However, we recommend that you use auto.exe. As you run auto.exe, a test pattern displays.
2. Press the **AUTO** key on the monitor.
3. Press the **MENU** key to access the monitor On-Screen Display (OSD) menu.
4. Use the ◀ or ▶ keys to select **DISPLAY** and press the **ENTER** key to enter the menu.
5. If you notice a vertical noise (like a curtain effect-shimmering of vertical lines), press the ◀ or ▶ keys to select **Pixel Clock** and press the **ENTER** key. Then press the ◀ or ▶ keys to adjust the monitor until the noise disappears.
6. If you notice a horizontal noise, press the ◀ or ▶ keys to select **Phase** and press the **ENTER** key. Then press the ◀ or ▶ keys to adjust the monitor until the noise disappears.



## 6. How to adjust your monitor

### The control panel

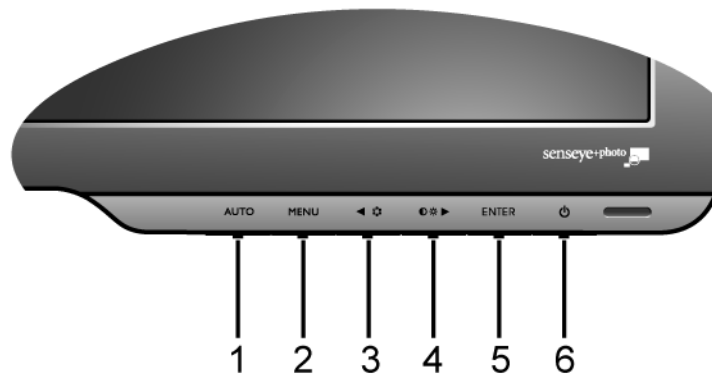

1. “AUTO”: Adjust vertical position, phase, horizontal position and pixel clock automatically.
2. “MENU” key: Activate OSD main menu and return to the previous menu or exit OSD.
3. ◀ /Mode key: For Left/Decrease adjustment. The key is the hot key for Mode.
4. ▶ /Contrast/Brightness key: For Right/Increase adjustment. The key is the hot key for Brightness and Contrast.
5. “ENTER” key: Enter sub menus and select items. This key is also the hot key for Input.
6. “Power”: Turn the power on or off.



OSD = On Screen Display.

The hot-keys will display a graduated scale for adjusting the value of that setting, and will only operate while the OSD menu is not currently displaying. Hot-key displays will disappear after a few seconds of no key activity. See [Hot key mode on page 18](#).

## Hot key mode

The monitor keys perform as hotkeys to provide direct access to particular functions whenever the menu isn't currently displaying on-screen.

### Brightness and Contrast hot keys

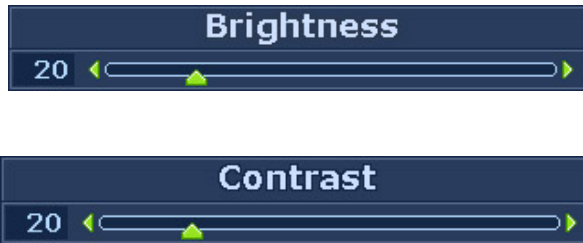

Press the **▶** key to display the **Brightness** and **Contrast** indicators. Further press the the **◀** or **▶** keys, then the **ENTER** key to select **Brightness** or **Contrast**. The **▶** key will increase the level, while the **◀** key will decrease the level.

To exit, press the **MENU** key.

### Mode hot key

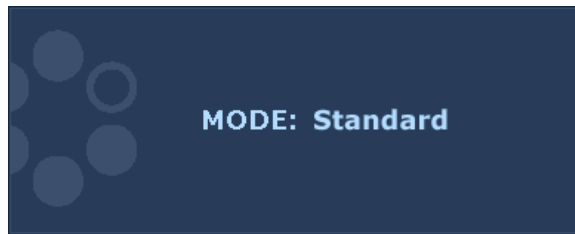

Press the **◀** key continually to switch between the 5 modes for the main window, including **Standard**, **Movie**, **Dynamics**, **Photo**, and **sRGB**. The setting will take effect immediately.

See also [Picture Mode on page 24](#).

### Input hot key

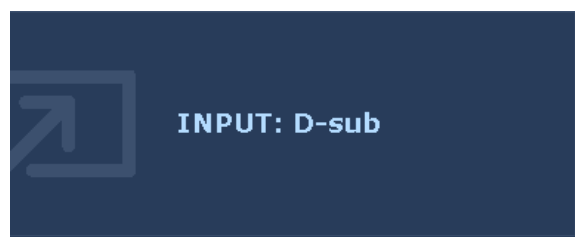

Press the **ENTER** key to toggle between different PC video signal inputs that may be connected to your monitor. The setting will take effect immediately.

See also [Input on page 26](#).

## Main menu mode

You can use the OSD (On Screen Display) menu to adjust all the settings on your monitor. Press the **MENU** key to display the following main OSD menu.



There are four main OSD menus:

1. Display
2. Picture
3. Picture Advanced
4. System

Use the ◀ (left) or ▶ (right) keys to highlight a menu item, and press the **ENTER** key to enter the Menu item settings.



The OSD menu languages may differ from the product supplied to your region, see “[Language on page 26](#)” under “OSD Settings” for more details.

For more information on each menu, please refer to the following pages:

- [Display menu on page 20](#)
- [Picture menu on page 22](#)
- [Picture Advanced menu on page 24](#)
- [System menu on page 26](#)

## Display menu



1. Press the **MENU** key to display the main menu.
2. Press the ◀ or ▶ keys to select **DISPLAY** and then press the **ENTER** key to enter the menu.
3. Press the ◀ or ▶ keys to move the highlight to a menu item and then press the **ENTER** key to select that item.
4. Press the ◀ or ▶ keys to make adjustments or selections.
5. To return to the previous menu, press the **MENU** key.

Item	Function	Operation	Range
Auto Adjustment	<p>Optimizes and adjusts the screen settings automatically for you. The <b>AUTO</b> key is a 'hot-key' for this function.</p> <p>☞ When you connect a digital video output using a digital (DVI) cable to your monitor, the <b>AUTO</b> key and the <b>Auto Adjustment</b> function will be disabled.</p>	Press the <b>ENTER</b> key to select this option and make adjustment.	

H. Position	Adjusts the horizontal position of the screen image.	Press the ◀ or ▶ keys to adjust the value.	0 to 100
V. Position	Adjusts the vertical position of the screen image.		0 to 100
Pixel Clock	Adjusts the pixel clock frequency timing to synchronize with the analog input video signal. Not applicable to a digital input signal.  See also: <a href="#">Picture optimization on page 16.</a>		0 to 100
Phase	Adjusts the pixel clock phase timing to synchronize with the analog input video signal. Not applicable to a digital input signal.  See also: <a href="#">Picture optimization on page 16.</a>		0 to 63

## Picture menu



1. Press the **MENU** key to display the main menu.
2. Press the ◀ or ▶ keys to select **PICTURE** and then press the **ENTER** key to enter the menu.
3. Press the ◀ or ▶ keys to move the highlight to a menu item and then press the **ENTER** key to select that item.
4. Press the ◀ or ▶ keys to make adjustments or selections.
5. To return to the previous menu, press the **MENU** key.

Item	Function	Operation	Range
Brightness	Adjusts the balance between light and dark shades.  ☞ The function is not available for use when <b>DynamicContrast</b> is on.	Press the ▶ key to increase the brightness and press the ◀ key to decrease the brightness.	0 to 100
Contrast	Adjusts the degree of difference between darkness and lightness.  ☞ The function is not available for use when <b>DynamicContrast</b> is on.	Press the ▶ key to increase the contrast and press the ◀ key to decrease the contrast.	0 to 100
Sharpness	Adjusts the clarity and visibility of the edges of the subjects in the image.	Press the ▶ key to improve the crispness of the display and press the ◀ key to have softness effect on the display.	1 to 5
<b>Color</b> - Press <b>ENTER</b> to enter the <b>Color</b> menu.			

Normal	Allows video and still photographs to be viewed with natural coloring. This is the factory default color.		
Bluish	Applies a cool tint to the image and is factory pre-set to the PC industry standard white color.	Press the ◀ or ▶ keys to select this option.	
Reddish	Applies a warm tint to the image and is factory pre-set to the news print standard white color.		
User Mode	Tailors the image color tint. The blend of the Red, Green and Blue primary colors can be altered to change the color tint of the image. Decreasing one or more of the colors will reduce their respective influence on the color tint of the image. e.g. if you reduce the Blue level the image will gradually take on a yellowish tint. If you reduce Green, the image will become a magenta tint.		Press the ◀ or ▶ keys and the <b>ENTER</b> key to select <b>Red</b> , <b>Green</b> , or <b>Blue</b> . Then use the ◀ or ▶ keys to make the color adjustments.
Reset Color	Resets the <b>User Mode</b> custom color settings to the factory defaults.	Press the ◀ or ▶ keys to change the settings.	<ul style="list-style-type: none"> <li>• YES</li> <li>• NO</li> </ul>
Press <b>MENU</b> to leave the <b>Color</b> menu.			
DynamicContrast (available when the <b>Picture Mode</b> is set to <b>Photo</b> , <b>Dynamics</b> , or <b>Movie</b> )	The function is to automatically detect the distribution of an input visual signal, and then to create the optimal contrast. The higher the level, the more detailed picture possible will be displayed.   Activating <b>DynamicContrast</b> will disable <b>Brightness</b> and <b>Contrast</b> controls.	Press the <b>ENTER</b> key to select this option. Press the ◀ or ▶ keys to change the settings.	0 to 5

## Picture Advanced menu



1. Press the **MENU** key to display the main menu.
2. Press the ◀ or ▶ keys to select **PICTURE ADVANCED** and then press the **ENTER** key to enter the menu.
3. Press the ◀ or ▶ keys to move the highlight to a menu item and then press the **ENTER** key to select that item.
4. Press the ◀ or ▶ keys to make adjustments or selections.
5. To return to the previous menu, press the **MENU** key.

Item	Function	Operation	Range
Picture Mode	<p>Selects a picture mode that best suits the type of images shown on the screen.</p> <ul style="list-style-type: none"> <li>• Standard - for basic PC application.</li> <li>• Movie - for viewing videos.</li> <li>• Dynamics - for viewing landscape-specific videos and playing games.</li> <li>• Photo - for viewing still images.</li> <li>• sRGB - for better color matching representation with the peripheral devices, such as printers, DSCs, etc.</li> </ul>	Press the ◀ or ▶ keys to change the settings.	<ul style="list-style-type: none"> <li>• Standard</li> <li>• Movie</li> <li>• Dynamics</li> <li>• Photo</li> <li>• sRGB</li> </ul>



<p>Senseye Demo (available when the <b>Picture Mode</b> is set to <b>Photo</b>, <b>Dynamics</b>, or <b>Movie</b>)</p>	<p>Displays the preview of screen images under the selected mode from <b>Picture Mode</b>. The screen will be divided into two windows; the left window demonstrates images of Standard mode, while the right window presents the images under the specified mode.</p>	<p>Press the ◀ or ▶ keys to change the settings.</p>	<ul style="list-style-type: none"> <li>• ON</li> <li>• OFF</li> </ul>
<p>Display Mode</p>	<p>This feature is provided to allow aspect ratio's other than 16:9 to be displayed without geometric distortion.</p> <ul style="list-style-type: none"> <li>• Full - Scales the input image to fill the screen. Ideal for 16:9 aspect images.</li> <li>• Aspect - The input image is displayed without geometric distortion filling as much of the display as possible.</li> </ul> <p>☞ <b>Aspect</b> is not available when the video content is in a 16:9 aspect ratio.</p>	<p>Press the ◀ or ▶ keys to change the settings.</p>	<ul style="list-style-type: none"> <li>• Full</li> <li>• Aspect</li> </ul>

## System menu



1. Press the **MENU** key to display the main menu.
2. Press the **◀** or **▶** keys to select **SYSTEM** and then press the **ENTER** key to enter the menu.
3. Press the **◀** or **▶** keys to move the highlight to a menu item and then press the **ENTER** key to select that item.
4. Press the **◀** or **▶** keys to make adjustments or selections.
5. To return to the previous menu, press the **MENU** key.

Item	Function	Operation	Range
Input	Use this to change the input to that appropriate to your video cable connection type.	Press the <b>◀</b> or <b>▶</b> keys to change the settings.	<ul style="list-style-type: none"> <li>• DVI</li> <li>• D-sub</li> </ul>
<b>OSD Settings</b> - Press <b>ENTER</b> to enter the <b>OSD Settings</b> menu.			
Language	Sets the OSD menu language.	Press the <b>◀</b> or <b>▶</b> keys to change the settings.  ⓘ The language options displayed on your OSD may differ from those shown on the right, depending on the product supplied in your region.	<ul style="list-style-type: none"> <li>• English</li> <li>• French</li> <li>• German</li> <li>• Italian</li> <li>• Spanish</li> <li>• Polish</li> <li>• Czech</li> <li>• Hungarian</li> <li>• Serbo-Croatian</li> <li>• Romanian</li> <li>• Dutch</li> <li>• Russian</li> <li>• Swedish</li> <li>• Portuguese</li> <li>• Japanese</li> <li>• Traditional Chinese</li> <li>• Simplified Chinese</li> </ul>

H. Position	Adjusts the horizontal position of the OSD menu.	Press the ◀ or ▶ keys to change the settings.	0 to 100
V. Position	Adjusts the vertical position of the OSD menu.		0 to 100
Display Time	Adjusts the display time of the OSD menu.		<ul style="list-style-type: none"> <li>• 5 Sec.</li> <li>• 10 Sec.</li> <li>• 15 Sec.</li> <li>• 20 Sec.</li> <li>• 25 Sec.</li> <li>• 30 Sec.</li> </ul>
OSD Lock	Prevents all the monitor settings from being accidentally changed. When this function is activated, the OSD controls and hotkey operations will be disabled.	<p>Press the ◀ or ▶ keys to change the settings.</p> <p> To unlock the OSD controls when the OSD is preset to be locked, press and hold the 'MENU' key for 15 seconds to enter the 'OSD Lock' option and make changes. Alternatively, you may use the ◀ or ▶ keys to select 'NO' in the 'OSD Lock' submenu from the 'OSD Settings' menu, and all OSD controls will be accessible.</p>	<ul style="list-style-type: none"> <li>• YES</li> <li>• NO</li> </ul>
Press <b>MENU</b> to leave the <b>OSD Settings</b> menu.			
DDC/CI*	Allows the monitor settings to be set through the software on the PC.	Press the <b>ENTER</b> key to select this option. Press the ◀ or ▶ keys to change the settings.	<ul style="list-style-type: none"> <li>• ON</li> <li>• OFF</li> </ul>
Information	Displays the current monitor property settings.	Press the <b>ENTER</b> key to select this option.	
Reset All	Resets all mode, color and geometry settings to the factory default values.	Press the ◀ or ▶ keys to change the settings.	<ul style="list-style-type: none"> <li>• YES</li> <li>• NO</li> </ul>



\*DDC/CI, short for Display Data Channel/Command Interface, which was developed by Video Electronics Standards Association (VESA). DDC/CI capability allows monitor controls to be sent via the software for remote diagnostics.

## 7. Troubleshooting

### Frequently asked questions (FAQ)

② The image is blurred:

☞ Read the instructions on the link "**Adjusting the Screen Resolution**" on the CD, and then select the correct resolution, refresh rate and make adjustments based on these instructions.

☞ How do you use a VGA extension cable?

Remove the extension cable for the test. Is the image now in focus? If not, optimize the image by working through the instructions in the "**Adjusting the refresh rate**" section on the link "**Adjusting the Screen Resolution**". It is normal for blurring to occur due to conduction losses in extension cables. You can minimize these losses by using an extension cable with better conduction quality or with a built-in booster.

☞ Does the blurring only occur at resolutions lower than the native (maximum) resolution?

Read the instructions on the link "**Adjusting the Screen Resolution**" on the CD. Select the native resolution.

② Pixel errors can be seen:

☞ One of several pixels is permanently black, one or more pixels are permanently white, one or more pixels are permanently red, green, blue or another color.

- Clean the LCD screen.
- Cycle power on-off.
- These are pixels that are permanently on or off and is a natural defect that occurs in LCD technology.

② The image has a faulty coloration:

☞ It has a yellow, blue or pink appearance.

Select MENU > PICTURE > Color > Reset Color, and then choose "YES" in the "Caution" message box to reset the color settings to the factory defaults.

If the image is still not correct and the OSD also has faulty coloration, this means one of the three primary colors is missing in the signal input. Now check the signal cable connectors. If any pin is bent or broken off, please contact your dealer to get necessary support.

② No image can be seen:

☞ Is the prompt on the display illuminated in green?

If the LED is illuminated in green and there is a message "Out of Range" on the screen, this means you are using a display mode that this monitor does not support, please change the setting to one of the supported mode. Please read the "**Preset display modes**" section from the link "**Adjusting the Screen Resolution**".

② Faint shadow from the static image displayed is visible on the screen:

- Activate the power management function to let your computer and monitor go into a low power "sleep" mode when not actively in use.
- Use a screensaver to prevent the occurrence of image retention.

② Is the prompt on the display illuminated in orange?

If the LED is illuminated in orange, the power management mode is active. Press any button on the computer keyboard or move the mouse. If that does not help, check the signal cable connectors. If any pin is bent or broken off, please contact your dealer to get necessary support.

☞ Is the prompt on the display not illuminated at all?

Check the power input jack, the external power adapter and the mains power switch.

② The image is distorted, flashes or flickers:

☞ Read the instructions on the link "**Adjusting the Screen Resolution**" on the CD, and then select the correct resolution, refresh rate and make adjustments based on these instructions.

☞ You are running the monitor at its native resolution, but the image is still distorted.

Images from different input sources may appear distorted or stretched on the monitor running at its native resolution. To have the optimal display performance of each type of input sources, you can use the "Display Mode" function to set a proper aspect ratio for the input sources. See [Display Mode on page 25](#) for details.

② The image is displaced in one direction:

☞ Read the instructions on the link "**Adjusting the Screen Resolution**" on the CD, and then select the correct resolution, refresh rate and make adjustments based on these instructions.

② The OSD controls are inaccessible:

- To unlock the OSD controls when the OSD is preset to be locked, press and hold the "MENU" key for 15 seconds to enter the "OSD Lock" option and make changes.
- Alternatively, you may use the ◀ or ▶ keys to select "NO" in the "OSD Lock" submenu from the "OSD Settings" menu (under SYSTEM), and all OSD controls will be accessible.

## Need more help?

If your problems remain after checking this manual, please contact your place of purchase or e-mail us at: [Support@BenQ.com](mailto:Support@BenQ.com)